

# Potain MC 175B

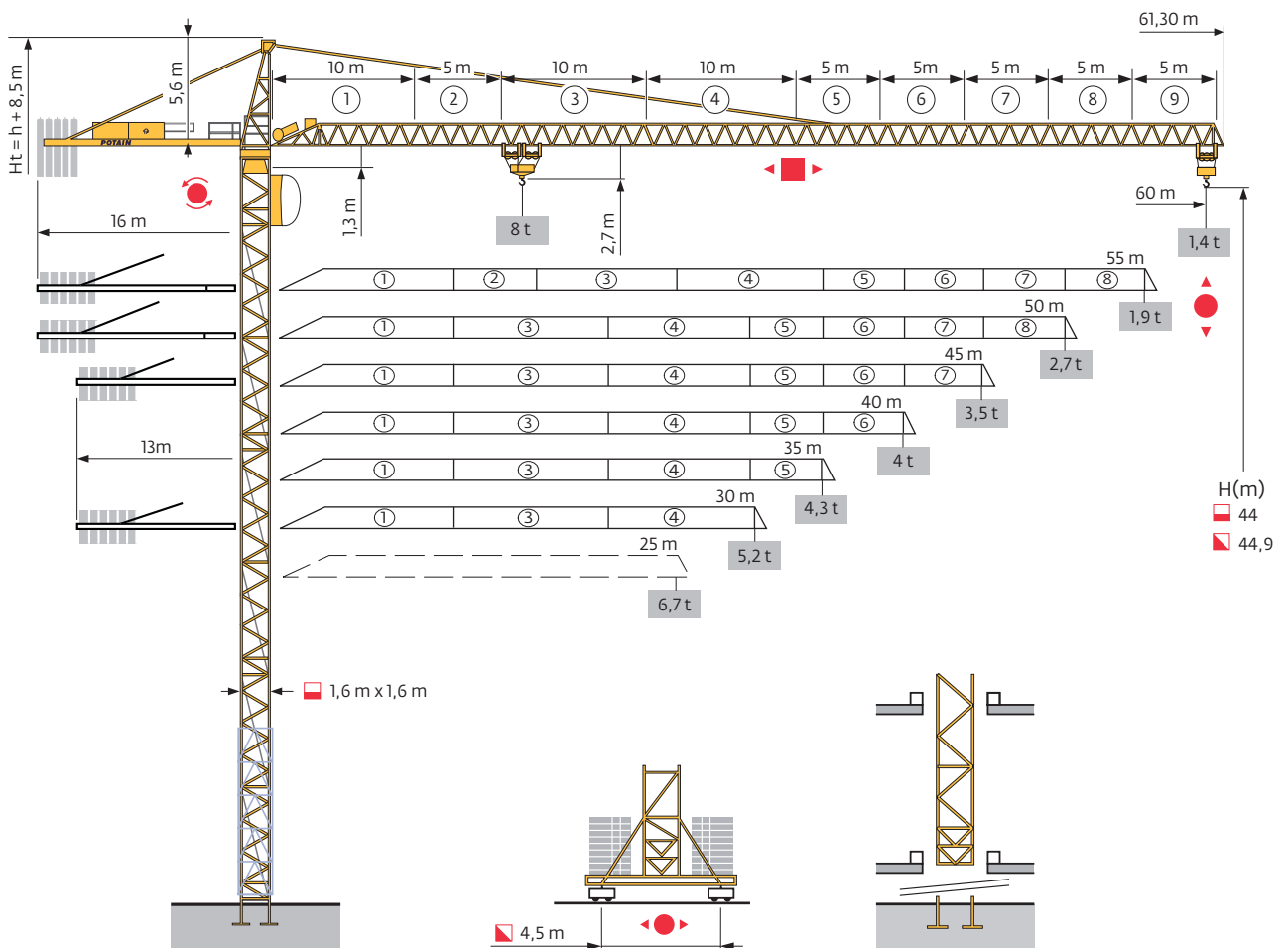

Mât - Réactions / Mast - Reaktionskräfte / Mast - Reactions / Mástil - Reacciones / Torre - Reazioni  
 Tramo - Reações / Реакция опор мачты

□ 1,6 m

▲▲▲ 30 m → 60 m

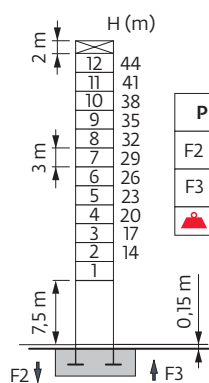

P 16 A	
F2	• 102 t
	■ 139 t
F3	• 67 t
	■ 109 t
	▲ 42 t

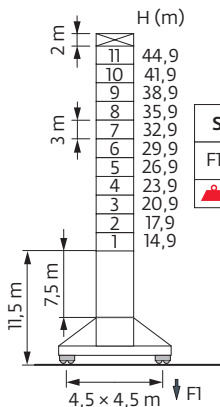

SB 16 A	
F1	• 68 t
	■ 88 t
	▲ 50 t

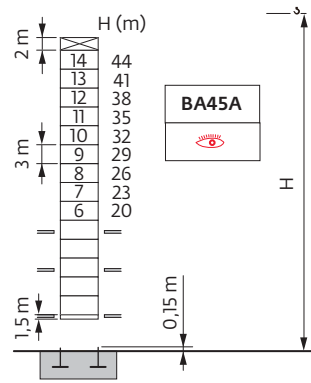

BA45A	
	▲ 50 t

Télescopage sur dalles / Kletterkrane im Gebäude / Climbing Crane / Telescopage grua trepadora / Gru in cavedio  
 Telescopagem sobre lajes / Кран, ползущий внутри здания

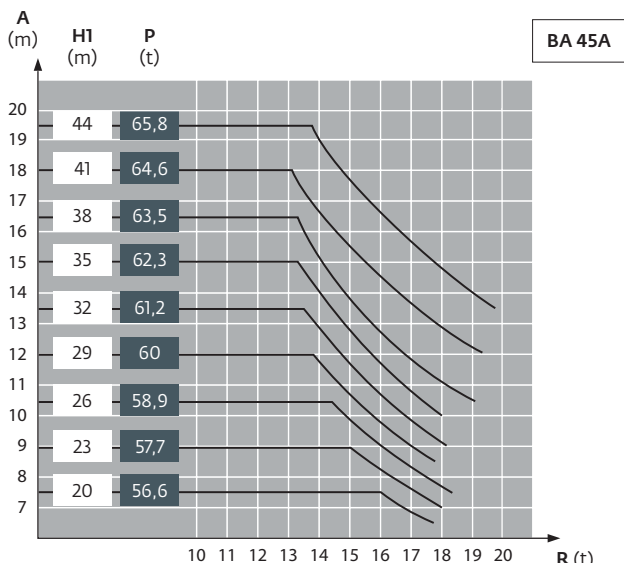
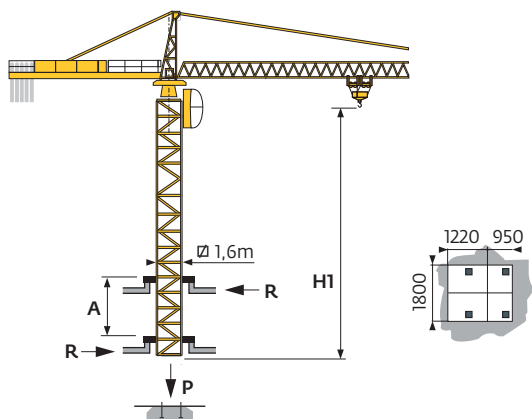

Ancrages / Verankerungen / Anchorages / Anclajes / Ancoraggi  
 Ancoragem / Анкера

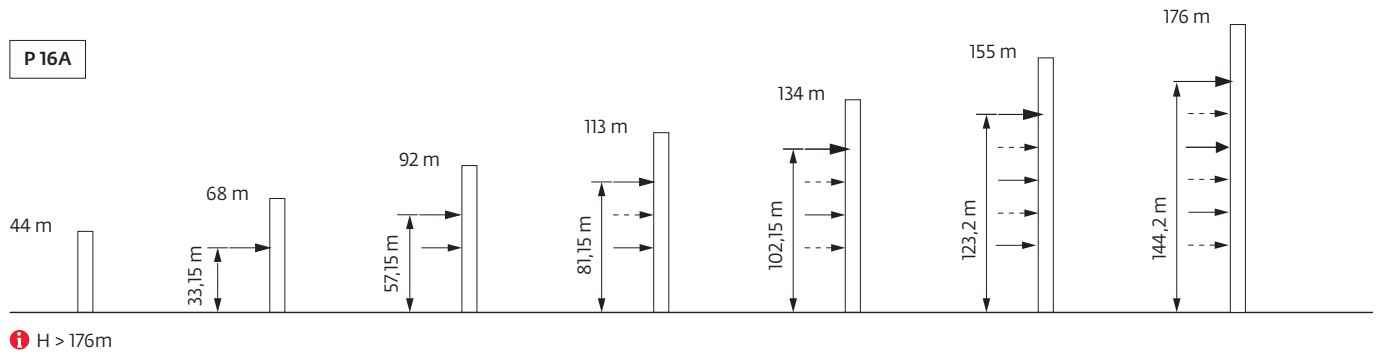



Courbes de charges / Lastkurven / Load curves / Curvas de cargas / Curve di carico  
 Curvas de carga / Кривые нагрузок



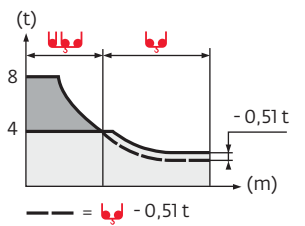

60 m	3,1	▶	13,6	15	17	20	22	24	26,1	27	30	32	35	37	40	42	45	47	50	52	55	57	60	m
	8		7,2	6,1	5	4,5	4	4	3,9	3,4	3,1	2,8	2,6	2,4	2,25	2,1	1,95	1,8	1,7	1,6	1,5	1,4		t
55 m	3,1	▶	15,6	17	20	22	25	27,5	29,9	31	32	35	37	40	42	45	47	50	52	55				m
	8		7,2	5,9	5,3	4,5	4	4	3,8	3,7	3,3	3,1	2,8	2,7	2,45	2,3	2,15	2,05	1,9					t
50 m	3,1	▶	18,6	20	22	25	27	30	32	33	36	37	40	42	45	47	50							m
	8		7,4	6,6	5,6	5,1	4,5	4,2	4	4	3,9	3,5	3,3	3,1	2,9	2,7								t
45 m	3,1	▶	20,8	22	25	27	30	32	35	36,8	40,1	42	45											m
	8		7,5	6,4	6	5,2	4,8	4,3	4	4	3,8	3,5												t
40 m	3,1	▶	20,8	22	25	27	30	32	35	36,8	40													m
	8		7,5	6,4	6	5,2	4,8	4,3	4	4														t
35 m	3,1	▶	20,8	22	25	27	30	32	35															m
	8		7,5	6,4	6	5,2	4,8	4,3																t
30 m	3,1	▶	20,8	22	25	27	30																	m
	8		7,5	6,4	6	5,2																		t
25 m	3,1	▶	21,5	22	25																			m
	8		7,8	6,7																				t



Lest de base / Grundballast / Base ballast / Lastre de base / Zavorra di base  
 Lastro da base / Базовый Балласт

 1,6 m	<b>SB 16A</b> 	H (m)	44,9	41,9	38,9	35,9	32,9	29,9	26,9	23,9	20,9	17,9	14,9
		 (t)	72	60	54	54	54	54	54	54	54	54	54

Lest de contre-flèche / Gegenauslegerballast / Counter-jib ballast / Lastre de contra-flecha / Zavorra di controbraccio  
 Lastro da contra lança / Противовес стрелы

	3450 kg	2250 kg	 (kg)
60 m	4	2	18 300
55 m	3	3	17 100
50 m	3	2	14 850
45 m	5	1	19 500
40 m	4	2	18 300
35 m	3	3	17 100
30 m	3	2	14 850
25m	3	2	12 600



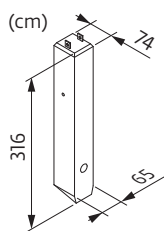

CD - 3450 kg

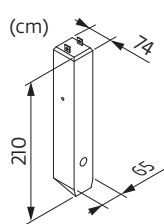









CE - 2250 kg

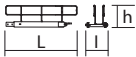
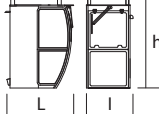
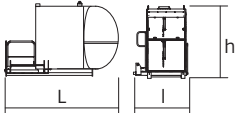
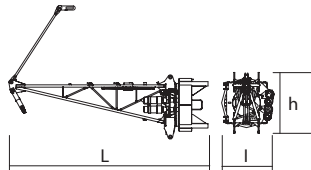
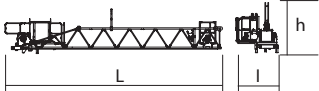
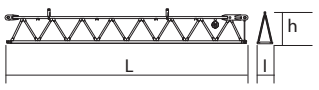
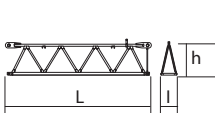
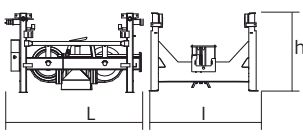

Encombrement et poids / Abmessungen und Gewicht / Dimensions and weight / Dimensiones y peso / Ingombro e peso  
 dimensões e pesos / габаритные размеры и вес

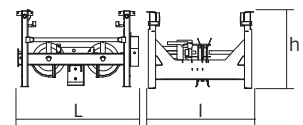
Partie tournante / Drehender Kranteil / Slewing crane part / Parte giratoria  
 Parte rotante / Parte rotativa / Поворотная часть :  60 m -  -  -  50LVF

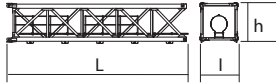
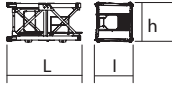
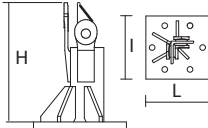
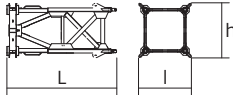
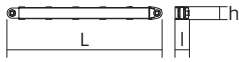
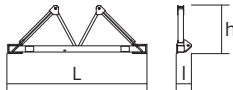

Partie tournante / Drehender Kranteil / Slewing crane part Parte giratoria / Parte rotante / Parte rotativa Поворотная часть	L (m)	I (m)	h (m)	kg (+/- 5%)	
Contre-flèche / Gegenausleger Counter-jib / Contra-flecha Controbraccio / Contra-lança Контр-стрела 	11,94	1,015	0,46	1610	
	3,43	1,015	0,34	530	
Cabine / Kabine Cab / Cabina Cabina / Cabina Кабина 	Smartview	1,675	1,175	2,305	385
Cabine / Kabine Cab / Cabina Cabina / Cabina Кабина 	V140S	3,4	1,9	2,57	1130
Porte-flèche / Auslegerträger Cathead / Porta-flecha Cuspide / Suporte de lança Оголовок 	6,64	2,2	1,68	5528	
Elément de flèche / Auslegerelement Jib section / Elemento de flecha Elemento di braccio / Elemento de lança Секция стрелы 	①	10,2	1,05	1,17	1560
Elément de flèche / Auslegerelement Jib section / Elemento de flecha Elemento di braccio / Elemento de lança Секция стрелы 	③ ④	10,2	1,05	1,424	1325
Elément de flèche / Auslegerelement Jib section / Elemento de flecha Elemento di braccio / Elemento de lança Секция стрелы 	② ⑤ ⑥ ⑦ ⑧ ⑨	5,136 5,175 5,175 5,175 5,175 5,175	1,05 1,05 1,05 1,05 1,05 1,05	1,424 1,171 1,171 1,171 1,171 1,171	749 520 395 314 262 262
Chariot / Laufkatze Trolley / Carrello Carro / Carro-distribuidor Тележка 	 -  -  8 t 4 t	1,423	1,302	0,96	239
Chariot / Laufkatze Trolley / Carrello Carro / Carro-distribuidor Тележка 	 -  -  8 t	1,478	1,302	0,96	234

Équipement de télescage / Teleskopierausrüstung / Telescoping equipment Equipo de telescopaje / Equipaggiamento di telescopaggio / Equipamento de telescopagem Оборудование для телескопирования	L (m)	l (m)	h (m)	kg (+/- 5%)	
Cage de télescage / Teleskopwagen Telescopic cage / Jaula de telescopaje Gabbia di telescopaggio / Gaiola de telescopagem для телескопирования крана	 1,6m	6,80	3,65	3,90	3430
<b>Mâture / Mastwerk / Masts</b> <b>Mástil / Torre / Coluna</b> <b>Мачты</b>					
S 46 J	 1,6m	7,74	1,67	1,73	2630
L 46 A1	 1,6m	3,24	1,67	1,73	1180
<b>Bases / Kranbasen / Crane bases</b> <b>Bases / Basi / Bases</b> <b>Фундамент под кран</b>					
Pieds de scellement / VerankerungsfüÙe Fixing angles / Pie de empotramiento Montante da annegare / Angulos fixadores анкера	 P 16 A R 16 A	0,49 0,5	0,49 0,5	1,135 0,685	145 185
Mât-châssis / Grundmasteinheit Basic mast unit / Tramo-chassis Elemento base / Tramo-chassis Мачта для крепления к шасси	 SB 16 A	3,626	1,954	1,954	2645
Haubans / Mastabstützungen Struts / Tornapuntas Puntoni / Escoras Растяжка	 SB 16 A	3,177	0,248	0,24	231
Sommier / Unterwagenhälfte Half-bearer / Testero Testata / Estrutura base Траверса	 SB 16 A	5,08	0,584	1,785	1115

400 V - 50 Hz									hp	kW					
	45 RCS 20	m/min	0 → 40      0 → 80		0 → 20      0 → 40				45	33	329 m				
		t	4      2		8      4										
	50 LVF 20 Optima	m/min	3,8 → 14,8 → 46 → 58 → 84 → 112							1,9 → 7,4 → 23 → 29 → 42 → 56			50	37	363 m
		t	4	4	4	3	2	1	8	8	8	6			
	5 D3 V4	m/min	15 - 30 - 58									5	3,7		
	6 DVF 4	m/min	0 - 6 → 76									5,5	4		
	RCV 145	rpm	0 → 0.8									2 x 6	2 x 4,4		
	RT 324 R ≥ 10 m	m/min	12,5 - 25									2 x 7	2 x 5,2		

CEI 38	IEC 38	
400 V (+10% -10%) 50 Hz		45 RCS : 60 kVA 55 RCS : 70 kVA 50 LVF : 70 kVA

480 V - 60 Hz									hp	kW					
	45 RCS 20	m/min	0 → 48      0 → 96		0 → 24      0 → 48				54	39,6	329 m				
		t	4      2		8      4										
	50 LVF 20 Optima	m/min	3,8 → 14,8 → 46 → 58 → 84 → 112							1,9 → 7,4 → 23 → 29 → 42 → 56			50	37	363 m
		t	4	4	4	3	2	1	8	8	8	6			
	5 D3 V4	m/min	18 - 36 - 69,6									6	4,4		
	6 DVF 4	m/min	0 - 6 → 76									6,6	4,8		
	RCV 145	rpm	0 → 0,96									2 x 7,2	2 x 5,28		
	RT 324 R ≥ 10 m	m/min	15 - 30									2 x 8,4	2 x 6,2		

CEI 38	IEC 38	
480 V (+6% -10%) 60 Hz		45 RCS : 72 kVA 55 RCS : 84 kVA 50 LVF : 70 kVA

50 LVF 20  
Optima

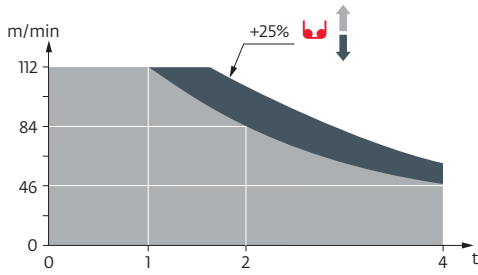

	FR	DE	EN	ES	IT	PT	RU
	Appel de flèche	Auslegerüberhöhung	Jib elevation	Elevación de la flecha	Inclinazione braccio	Desvio da lança	подъем стрелы
	Réactions en service	Reaktionskräfte in Betrieb	Reactions in service	Reacciones en servicio	Reazioni in servizio	Reacções em serviço	Реакция при работе
	Réactions hors service	Reaktionskräfte außer Betrieb	Reactions out of service	Reacciones fuera de servicio	Reazioni fuori servizio	Reacções fora de serviço	Реакция в покое
	A vide sans lest avec flèche et hauteur maximum	Gewicht ohne Last, ohne Ballast, mit Ausleger und max. Höhe	Weight without load, without ballast, with jib and max. height	Peso en vacío sin lastre, con flecha y altura máxima	Peso a vuoto, senza zavorra, con braccio e altezza massimi.	Peso em vazio sem lastro com lança e altura máxima.	Вес пустого, без балласта, со стрелой, максимальной высоты.
	Poids total du lest	Ballast-Gesamtgewicht	Total ballast weight	Peso total del lastre	Peso totale della zavorra	Peso total do lastro	Общий вес балласта
	Camion 13.4 m	Lkw 13.4 m	Lorry 13.4 m	Camión 13.4 m	Camion 13.4 m	Camião 13.4 m	Ррузовой автомобиль 13.4 м
	Conteneur High Cube 40"	Container High Cube 40"	Container High Cube 40"	Contenedor High cube 40"	Container High Cube 40"	Contentor 40"	Контейнер повышенной вместимости длиной 40"
	Cadre d'ancrage serré	Fester Verankerungsrahmen	Tightened anchorage frame	Marco de anclaje de apriete	Quadro di ancoraggio stretto	Quadro de amarração apertado	Прикрепленная анкерная рама
	Cadre d'ancrage desserré	Looser Verankerungsrahmen	Loosened anchorage frame	Marco de anclaje de desapriete	Quadro di ancoraggio allentato	Quadro de amarração solto	Отсоединенная анкерная рама
	Levage	Heben	Hoisting	Elevación	Sollevamento	Elevação	Подъем
	Distribution	Katzfahren	Trolleying	Distribución	Distribuzione	Distribuição	Перемещение по стреле
	Orientation	Schwenken	Slewing	Orientación	Rotazione	Rotação	Поворот
	Translation	Kranfahren	Travelling	Traslación	Traslazione	Traslacção	Перемещение крана
	Puissance nominale	Nennleistung	Rated power	Potencia nominal	Potenza nominale	Potência nominal	Номинальная мощность
	Voir télescopage sur dalles	Siehe Kletterkrane im Gebäude	See climbing crane	Vea grua trepadora	Consultare gru in cavedio	Ver telescopagem sobre lages	См. кран, ползущий внутри здания
	Nous consulter	AufAnfrage	Consult us	Consultarnos	Consultateci	Consultar-nos	Проконсультируйтесь у нас
	Document commercial non contractuel. Pour toute information technique se référer à la notice correspondante.	Unverbindliches Vertriebsdokument. Für technische Informationen, siehe die entsprechenden Anweisungen.	This commercial document is not legally binding. For any technical information, please refer to the corresponding instructions.	Documento comercial no contractual. Para cualquier información técnica, ver la noticia correspondiente.	Documento commerciale non vincolante, per tutte le informazioni tecniche fare riferimento al catalogo istruzioni.	Documento comercial não contractual. Para qualquer informação técnica complementar consultar as respectivas instruções.	Этот коммерческий документ не является юридически обязательным. Для получения технической информации, см. соответствующие инструкции.



www.manitowoc.com

**Americas**  
**Manitowoc, Wisconsin, USA**  
 Tel: +1 920 684 6621  
 Fax: +1 920 683 6277

**Shady Grove, Pennsylvania, USA**  
 Tel: +1 717 597 8121  
 Fax: +1 717 597 4062

**Europe, Middle East, Africa**  
**Ecully, France**  
 Tel: +33 (0)4 72 18 20 20  
 Fax: +33 (0)4 72 18 20 00

**China**  
**Shanghai, China**  
 Tel: +86 21 6457 0066  
 Fax: +86 21 6457 4955

**Greater Asia-Pacific**  
**Singapore**  
 Tel: +65 6264 1188  
 Fax: +65 6862 4040

Ref. MC 175B - 2012 18 - 0 EN